

Technical Data

Y.TU 160-D04

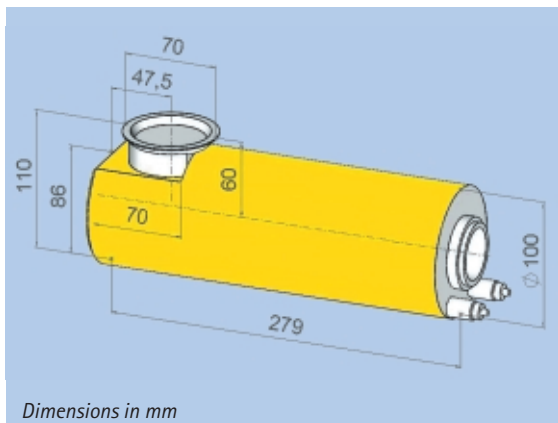

Dimensions in mm

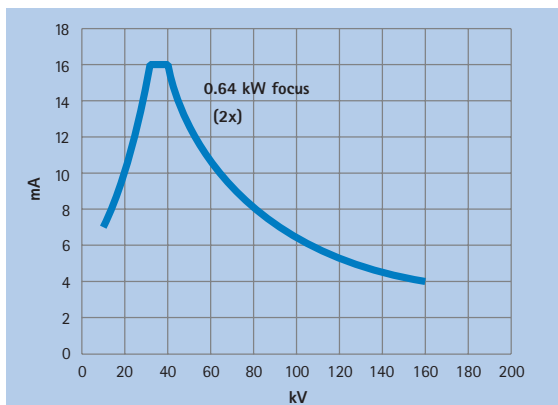

Loading data: shown are the max. permissible anode currents. Within the X-ray system these anode currents may be limited by power suppliers or generators.

Max. tube voltage	160 kV
Focal spot size (acc. EN12543) (acc. IEC336)	1.0 mm / 1.0 mm 0.4 / 0.4
Max. power (small / large focus)	0.64 kW / 0.64 kW
Max. tube current at 160 kV	4.0 mA / 4.0 mA
Emergent beam angle	40 °
Inherent filtration¹	0.8 mm Be + 3 mm Al
Leakage radiation²	< 2.5 mSv/h
Coolant	Water
Max. inlet temperature	45 °C
Min. flow rate	4 l/min
Environmental Conditions	
Operation temperature	-10 °C...+40°C
Storage temperature	-25 °C...+70°C
Relative humidity	
- Operation	90 %
- Storage	95 %
Weight	8 kg
H.V. connection³	Flange R12
Approval	PTB
Order No.	9421 172 30403

¹ Al-filter removable by using tools;
Al-filter acc. DIN 54113 and SSI FS1989:2

² Measured at 1.0 m distance from the focal spot with X-ray port closed and X-ray tube operating at full load.

³ Quick-lock adapter available