

MXR-350/26-90

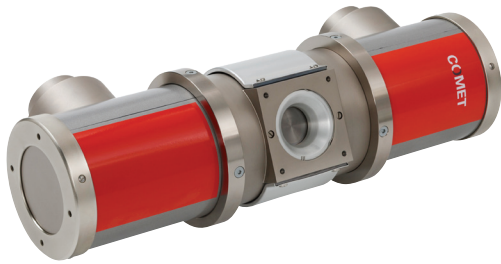

Product Description

The MXR-350/26-90 is a bipolar oil-cooled X-Ray tube assembly with integrated radiation protection. It comprises dual focal spot, a tungsten anode and a directional beam. The tube is specifically designed for non-destructive imaging applications.

Product Specifications

Nominal tube voltage.....	350 kV
Continuous rating.....	1500 W 4200 W
Focal spot acc. EN 12543.....	d = 3.0 mm d = 5.5 mm
Focal spot acc. ASTM E1165-12.....	N/A
Filament current, max.	4.9 A 4.6 A
Filament voltage, typical.....	2.6 V 6.4 V
Inherent filtration.....	3.0 mm Be
Target material.....	W
Target angle.....	20°
Radiation coverage.....	40°
Leakage radiation, max. at loading factors in 1m distance	5 mSv/h (350 kV; 12 mA)
Weight.....	40 kg
Terminal type	R24
Gapping spring-loaded HV-cable.....	2 rings visible (~7 mm)
Gapping non-spring-loaded HV-cable.....	5.5 - 6 mm
Grease quantity for HV-cable terminal.....	1.2 ml

Power rating charts

Power rating at given filament current

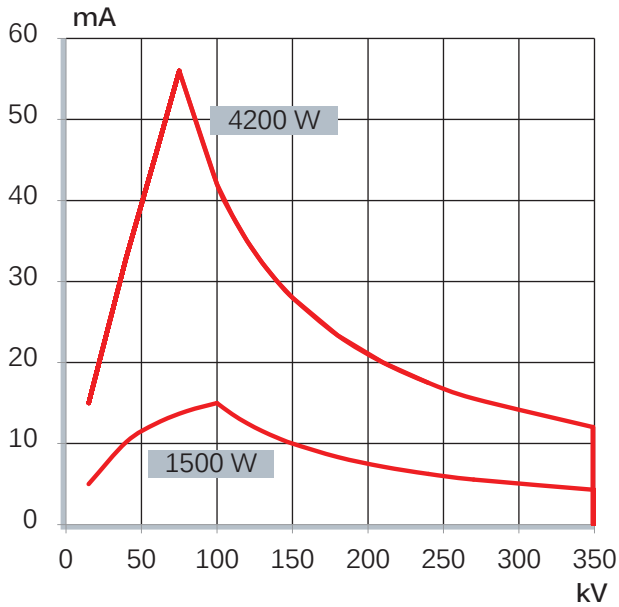

Connection of filament (C = Common)

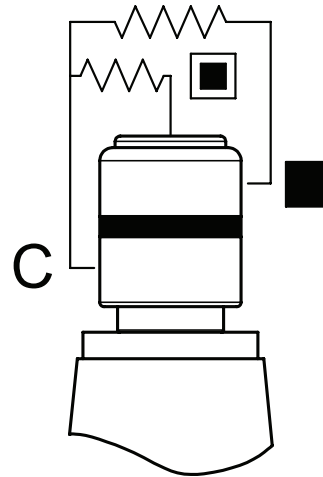

Cooling

Cooling medium	Oil
Cooling medium flow, min.	14 l/min
Cooling medium temperature at inlet, max.	50°C
Pressure at cooling medium inlet, max.	6 bar
Post-cooling time after switchoff, min.	2 min

Outline drawing

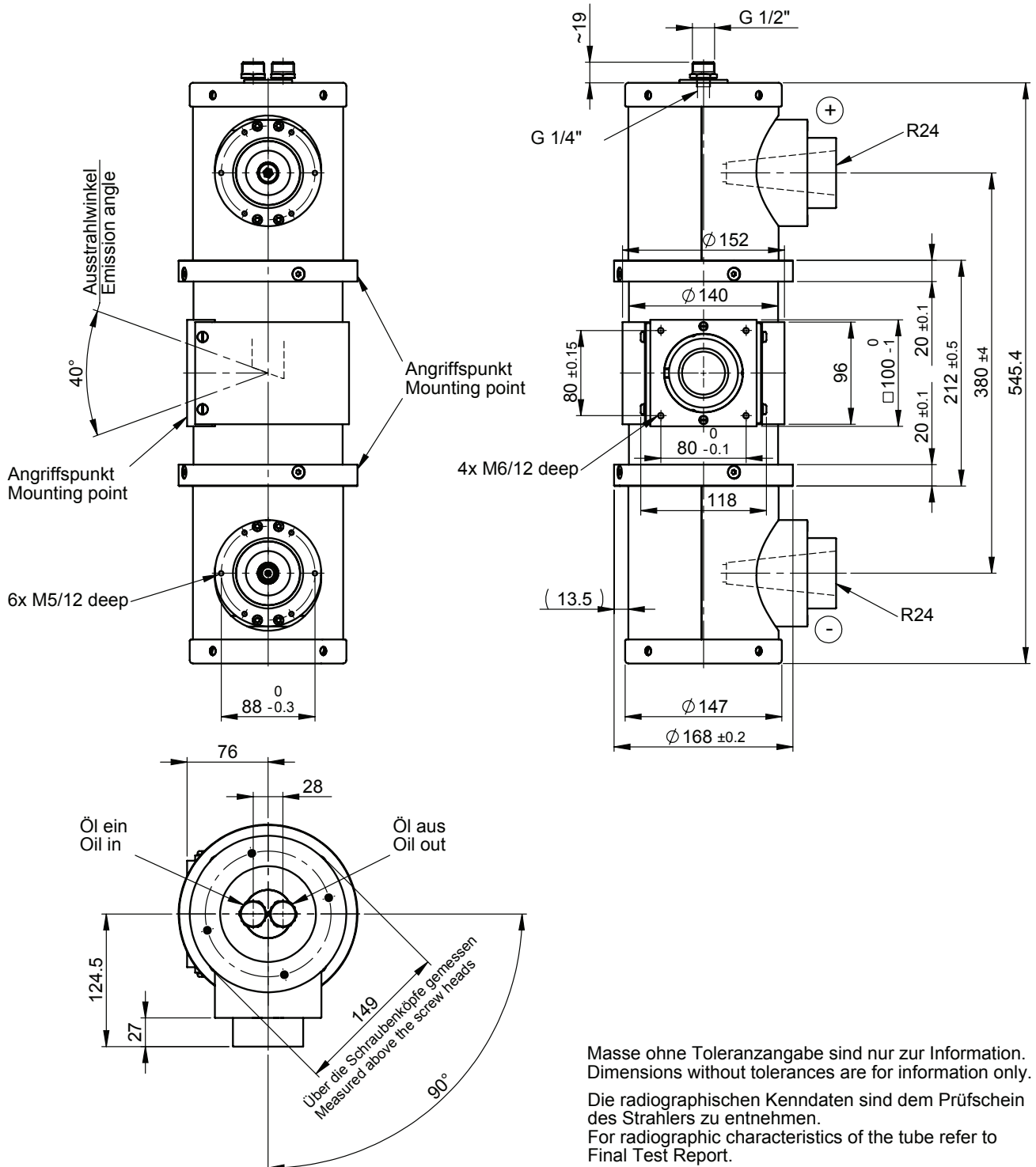

Masse ohne Toleranzangabe sind nur zur Information.
Dimensions without tolerances are for information only.

Die radiographischen Kenndaten sind dem Prüfschein des Strahlers zu entnehmen.
For radiographic characteristics of the tube refer to Final Test Report.

General information

General

The control of the high voltage and the filament current as well as the design of the cooling system and the radiation protection are within the responsibility of the original equipment manufacturer (OEM). For detailed instructions refer to our „X-Ray Tube Manual“. Provisions in the generator must assure that the X-Ray tube will be protected against overcurrent, over-voltage and lack of cooling. Otherwise the tube and/or the radiation protection may be damaged and become a hazard.

Connection of the X-ray tube

High-voltage cables must be installed by trained personnel only. Please proceed with the installation as follows: Cleaning, gapping & greasing (see values page 1), assembly and maintaining. Detailed instructions can be found in our „X-Ray Tube Manual“

Cooling

The customer is in charge that the cooling circuit is properly connected to the cooling system. Prior to operating the tube, the coolant must be turned on. Make sure that the coolant flow meets the required cooling conditions. When the tube is switched off, the coolant flow must continue for at least 2 minutes in order to protect the anode and the lead protection from overheating.

Radiation protection

When installing an X-ray tube assembly into a X-ray equipment and/or operating an X-ray equipment, the responsibility for radiation protection is with the user. Compliance with local regulatory requirements and limit values must be assured. After each tube exchange, repair, modification or upgrade of the unit a radiation protection integrity should be performed. Do not modify the tube assembly itself!

Return of Goods to COMET

Prior to shipment to COMET a Field Failure Report (FFR) will be required. The completed FFR has to be added to the shipping documents. The FFR can be downloaded from: www.comet-xray.com/Service